

# Minni lamir PN

## Hurða-/Gluggalöm

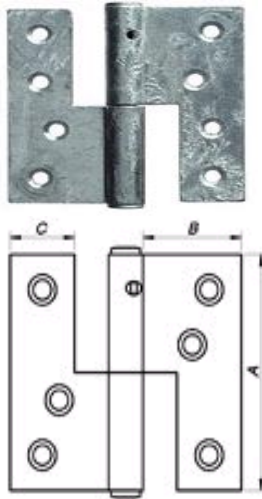

Art. nr.	HV	Pakning	Overflade	A mm	B mm	C mm	Dim.	Tap	Skrue bolt	Stk. pr. pk.
100212107	H	KP	varmforzinket m.t.	70	32	21	2	6,5	4	20
100222107	V	KP	varmforzinket m.t.	70	32	21	2	6,5	4	20
100312107	H	KP	varmforzinkrt m.t.	85	32	22	2,5	8	4	20
100322107	V	KP	varmforzinket m.t.	85	32	22	2,5	8	4	20
100412107	H	KP	varmforzinket m.t.	96	32	22	2,5	8	5	20
100422107	V	KP	varmforzinket m.t.	96	32	22	2,5	8	5	20
101011207	H	KP	pulverlak brun s.t.	109	38	24	2,5	8	5	20
101012107	H	KP	varmforzinket m.t.	109	38	24	2,5	8	5	20
101021207	V	KP	pulverlak brun s.t.	109	38	24	2,5	8	5	20
101022107	V	KP	varmforzinket m.t.	109	38	24	2,5	8	5	20

## Hurðalöm

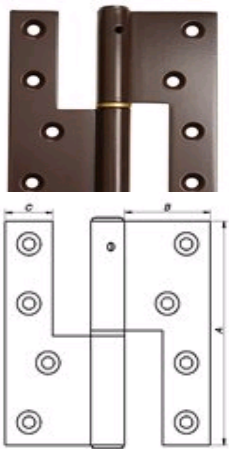

Art. nr.	HV	Pakning	Overflade	A mm	B mm	C mm	Dim.	Tap	Skrue bolt	Stk. pr. pk.
103111207	H	KP	pulverlak brun s.t.	123	45	25	4	9,5	5,5	10
103112107	H	KP	varmforzinket m.t.	123	45	25	4	9,5	5,5	10
103121207	V	KP	pulverlak brun s.t.	123	45	25	4	9,5	5,5	10
103122107	V	LP	varmforzinket m.t.	123	45	25	4	9,5	5,5	10
103512107	H	KP	varmforzinket m.t.	123	55	28	4	11	5,5	10
103522107	V	KP	varmforzinket m.t.	123	55	28	4	11	5,5	10

## Hurða-/Gluggalöm

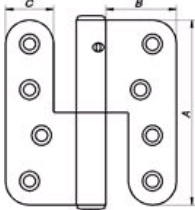
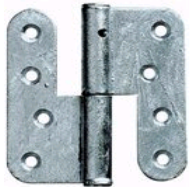

Art. nr.	HV	Pakning	Overflade	A mm	B mm	C mm	Dim.	Tap	Skrue bolt	Stk. pr. pk.
110312103	H	LP	varmforzinket m.t.	85	32	22	2,5	8	4	100
110312107	H	KP	varmforzinket m.t.	85	32	22	2,5	8	4	20
110322103	V	LP	varmforzinket m.t.	85	32	22	2,5	8	4	100
110322107	V	KP	varmforzinket m.t.	85	32	22	2,5	8	4	20

110422100 V

96 33 22 2,5 8

## Hurða-/Gluggalöm

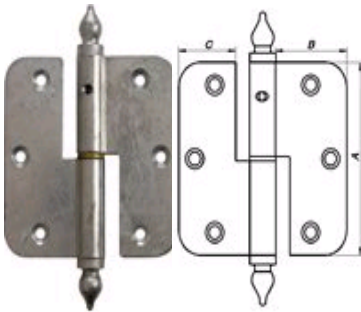

Art. nr.	HV	Pakning	Overflade	A mm	B mm	C mm	Dim.	Tap	Skrue bolt	Stk. pr. pk.
114712100	H	LP	varmforzinket m.t.	85	35	28,5	2,5	8	4	20
114712360	H	LP	elforzinket m.t.	85	35	28,5	2,5	8	4	20
114722100	V	LP	varmforzinket m.t.	85	35	28,5	2,5	8	4	20
114722360	V	LP	elforzinket m.t.	85	35	28,5	2,5	8	4	20

## Varakarmstykki

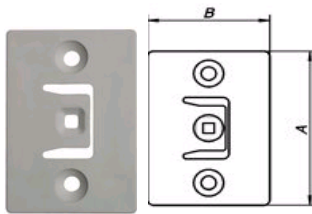

Art. nr.	Pakning	Overflade	A mm	B mm	Dim.	Stk. Pr. Enh.	Stk. pr. pk.
115609037	KP	PVC HVID	55	39	5,5	2	5
115609097	KP	PVC GULD	55	39	5,5	2	5

## Hurðalöm

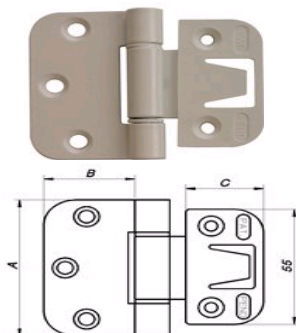

Art. nr.	Pakning	Overflade	A mm	B mm	C mm	Stk. Pr. Enh.	Stk. pr. pk.
115801237	KP	pulverlak hvid s.t.	65	34	29	2	5
115801297	KP	pulverlak guld m.t.	65	34	29	2	5

## Varakarmstykki

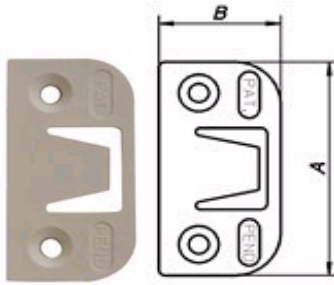

Art. nr.	Pakning	Overflade	A mm	B mm	Stk. Pr. Enh.	Stk. pr. pk.
115909037	KP	PVC hvid	55	29	2	5
115909097	KP	PVC guld	55	29	2	5

## Gluggalöm

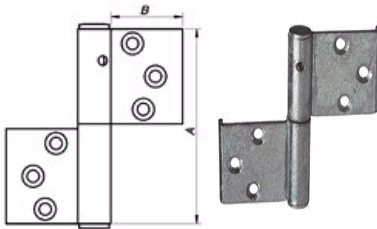

Art. nr.	HV	Pakning	Overflade	A mm	B mm	Dim.	Tap	Skrue bolt	Stk. pr. pk.
116412100	H	LP	varmforzinket m.t.	80	30	2,5	8	4	20
116422100	V	LP	varmforzinket m.t.	80	30	2,5	8	4	20
116512100	H	LP	varmforzinket m.t.	80	39	2,5	8	4	20
116522100	V	LP	varmforzinket mt.	80	39	2,5	8	4	20

## Gluggalöm COMBI 80mm

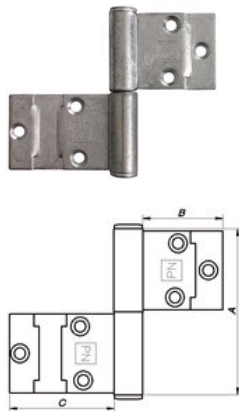

Art. nr.	HV	Overflade	A mm	B mm	C mm	Dim.	Skrue bolt	Stk. pr. pk.
117012100	H	varmforzinket m.t.	80	39	51	3	4	20
117012103	H	varmforzinket m.t.	80	39	51	3	4	100
117012360	H	elforzinket m.t.	80	39	51	3	4	20
117012510	H	silver	80	39	51	3	4	20
117012513	H	silver	80	39	51	3	4	100
117012530	H	hvid pulverlak m.t.	80	39	51	3	4	20
117022100	V	varmforzinket m.t.	80	39	51	3	4	20
117022103	V	varmforzinket	80	39	51	3	4	100
117022360	V	elforzinket m.t.	80	39	51	3	4	20
117022510	V	silver	80	39	51	3	4	20
117022513	V	silver	80	39	51	3	4	100
117022530	V	hvid pulverlak m.t.	80	39	51	3	4	20

## Gluggalöm COMBI 100mm

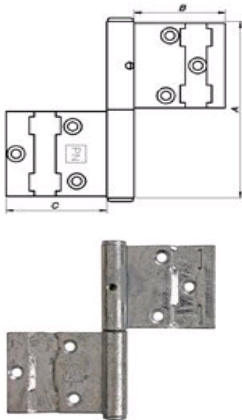

Art. nr.	HV	Overflade	A mm	B mm	C mm	Dim.	Skrue bolt	Stk. pr. pk.
117412100	H	varmforzinket m.t.	100	46	51	2,5	4	20
117412103	H	varmforzinket m.t.	100	46	51	2,5	4	100
117412360	H	elforzinket m.t.	100	46	51	2,5	4	20
117412530	H	hvid pulverlak m.t.	100	46	51	2,5	4	20
117422100	V	varmforzinket m.t.	100	46	51	2,5	4	20
117422103	V	varmforzinket m.t.	100	46	51	2,5	4	100
117422360	V	elforzinket m.t.	100	46	51	2,5	4	20
117422530	V	hvid pulverlak m.t.	100	46	51	2,5	4	20

## Stuðningslöm

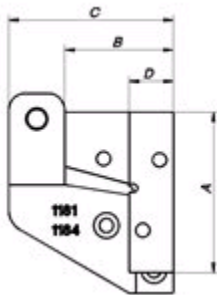

Art. nr.	HV	Overflade	A mm	B mm	C mm	Skrue bolt	Stk. pr. pk.
118110100	H	varmforzinket	57	39	59	4	20
118110300	H	elforzinket	57	39	59	4	20
118110510			57	39	59	4	20
118120100	V	varmforzinket	57	39	59	4	20
118120300	V	elforzinket	57	39	59	4	20
118120510			57	39	59	4	20

## Huðralöm 127x40 m/hring

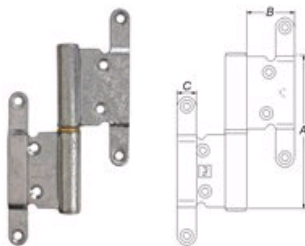

Art. nr.	HV	Overflade	A mm	B mm	C mm	Dim.	Skrue bolt	Stk. pr. pk.
118212100	H	varmforzinket m.t.	127	40	16	4	5	10
118212103	H	varmforzinket m.t.	127	40	16	4	5	50
118212360	H	elforzinket m.t.	127	40	16	4	5	10
118212513	H	grå pulverlak m.t.	127	40	16	4	5	50
118212530	H	hvid pulverlak m.t.	127	40	16	4	5	10
118222100	V	varmforzinket m.t.	127	40	16	4	5	10
118222103	V	varmforzinket	127	40	16	4	5	50
118222360	V	elforzinket m.t.	127	40	16	4	5	10
118222513	V	grå pulverlak m.t.	127	40	16	4	5	50
118222530	V	hvid pulverlak m.t.	127	40	16	4	5	10

## Hurðalöm Stillanleg

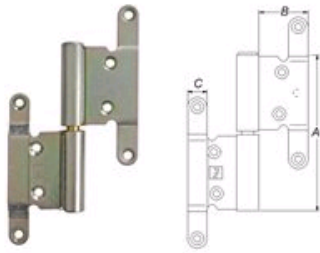

Art. nr.	HV	Overflade	A mm	B mm	C mm	Dim.	Skrue bolt	Stk. pr. pk.
118312360	H	elforzinket m.t.	127	40	16	4	5	10
118312510			127	40	16	4	5	10
118312530	H	hvid pulverlak m.t.	127	40	16	4	5	10
118322360	V	elforzinket m.t.	127	40	16	4	5	10
118322510			127	40	16	4	5	10
118322530	V	hvid pulverlak m.t.	127	40	16	4	5	10

## Hurðalöm 123x52 m/hring

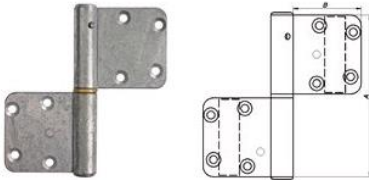

Art. nr.	HV	Overflade	A mm	B mm	Dim.	Skrue bolt	Stk. pr. pk.
118712100	H	varmforzinket m.t.	123	52	4	5	10
118712360	H	elforzinket m.t.	123	52	4	5	10
118722100	V	varmforzinket m.t.	123	52	4	5	10
118722360	V	elforzinket m.t.	123	52	4	5	10

## Hurðalöm stillanleg m/kúlulegu



Vörun.	HV		A mm	B mm	Dim	skrue bolt	stk.pr.pk.
018712490	H	grá	123	52	4	5	10
018722490	V	grá	123	52	4	5	10

## Gluggalöm með hnúð

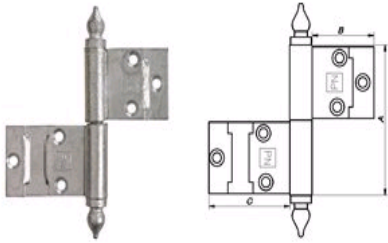

Art. nr.	HV	Overflade	A mm	B mm	C mm	Dim.	Skrue bolt	Stk. pr. pk.
119312100	H	varmforzinket m.t	80	39	50	3	4	20
119312103	H	varmforzinket	80	39	50	3	4	50
119312360	H	elforzinket m.t	80	39	50	3	4	20
119312530	H	hvid pulverlak m.t	80	39	50	3	4	20
119322100	V	varmforzinket m.t	80	39	50	3	4	20
119322103	V	varmforzinket	80	39	50	3	4	50
119322360	V	elforzinket m.t	80	39	50	3	4	20
119322530	V	hvid pulverlak m.t	80	39	50	3	4	20

## Gluggalöm COMBI 100mm

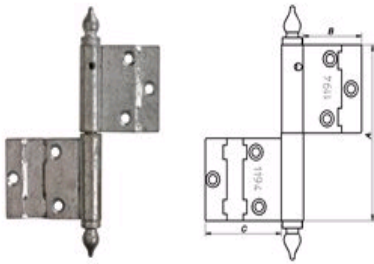

Art. nr.	HV	Overflade	A mm	B mm	C mm	Dim.	Skrue bolt	Stk. pr. pk.
119412100	H	varmforzinket m.t	100	39	50	3	4	20
119412360	H	elforzinket m.t	100	39	50	3	4	20
119412530	H	hvid pulverlak m.t	100	39	50	3	4	20
119422100	V	varmforzinket m.t	100	39	50	3	4	20
119422360	V	elforzinket m.t	100	39	50	3	4	20
119422530	V	hvid pulverlak m.t	100	39	50	3	4	20

## Hurðalöm rafgalv – gul

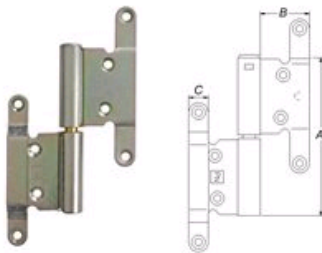

Art. nr.	HV	Overflade	A mm	B mm	C mm	Dim.	Skrue bolt	Stk. pr. pk.
119612360	H	elforzinket m.t	127	40	16	4	5	10
119612530	H	hvid pulverlak m.t.	127	40	16	4	5	10
119622360	V	elforzinket m.t	127	40	16	4	5	10
119622530	V	hvid pulverlak m.t.	127	40	16	4	5	10

## Hurðalöm Hvít m/hnúð

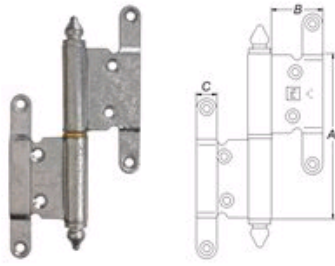

Art. nr.	HV	Overflade	A mm	B mm	C mm	Dim.	Skrue bolt	Stk. pr. pk.
119712100	H	varmforzinket m.t	127	40	16	4	5	10
119712360	H	elforzinket m.t.	127	40	16	4	5	10
119712530	H	hvid pulverlak m.t.	127	40	16	4	5	10
119722100	V	varmforzinket m.t	127	40	16	4	5	10
119722360	V	elforzinket m.t.	127	40	16	4	5	10
119722530	V	hvid pulverlak m.t.	127	40	16	4	5	10

## Hringir fyrir lamir

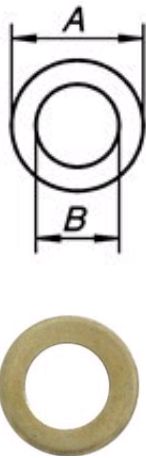

Art. nr.	Pakning	Overflade	A mm	B mm	Tap	Dim.	Stk. pr. pk.
138607000	LP	messing	10,5	7	6,5	2	100
138707000	LP	messing	18	10,5	10,5	3	100
138807000	LP	messing	14	8,5	8	2	100
138807001	SB	messing	14	8,5	8	2	10
139007000	LP	messing	16,5	8,5	8	2	100
139107000	LP	messing	16,5	10	9,5	3	100
139107001	SB	messing	16,5	10	9,5	3	10
139207000	LP	messing	18,5	9,7	9,5	3	100
139307000	LP	messing	19,5	11,5	11	3	100
139307001	SB	messing	19,5	11,5	11	3	10
139407000	LP	messing	22,5	13,5	13	3	100

## Skápalöm stungin Króm

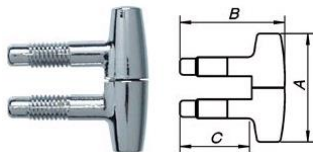

Art. nr.	Pakning	Overflade	A mm	B mm	C mm	Dim.	Stk. Pr. Enh.	Stk. pr. pk.
140209701	SB	forkromet	34	33	22	M6	2	10

## Skápalöm stungin Kopar

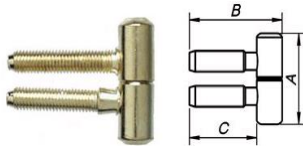

Art. nr.	Pakning	Overflade	A mm	B mm	C mm	Dim.	Stk. Pr. Enh.	Stk. pr. pk.
140309901	SB	formessinget	26	32	23	M6	2	10

## Skápalöm innstungin

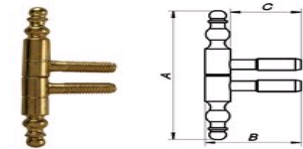

Art. nr.	Pakning	Overflade	A mm	B mm	C mm	Dim.	Stk. Pr. Enh.	Stk. pr. pk.
140401901	SB	formessinget	65	30	22	M5	1	5
140409601	SB	antik	65	30	22	M5	1	5

## Skápalöm 60mm yfirfeld

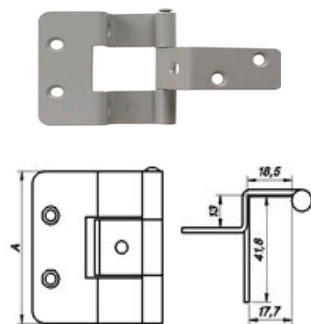

Art. nr.	Pakning	Overflade	A mm	Dim.	Tap	Skrue bolt	Stk. pr. pk.
142203217	KP	grá pulverlak løs s.t	60	2	4	3,5	20
142203237	KP	hvid pulverlak løs s.t	60	2	4	3,5	20
142303217	KP	grá pulverlak løs s.t	60	2	4	3,5	20
142303237	KP	hvid pulverlak løs s.t	60	2	4	3,5	20

## Skápalöm Nikkelhúð m/Pumpu

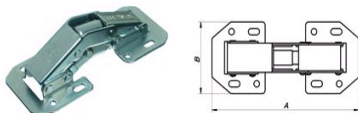

Art. nr.	Pakning	Overflade	A mm	B mm	Stk. Pr. Enh.	Stk. pr. pk.
143909608	PP	forniklet	105	44	2	10

## Skápalöm yfirfeld kopar

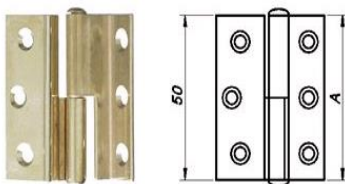

Art. nr.	HV	Pakning	Overflade	A mm	B mm	C mm	Dim.	Tap	Skrue bolt	Stk. pr. pk.
148117000	H	LP	messing m.t.	50	15	12	1,5	4	3	20
148117001	H	SB	messing m.t.	50	15	12	1,5	4	3	5
148127000	V	LP	messing m.t.	50	15	12	1,5	4	3	20
148127001	V	SB	messing m.t.	50	15	12	1,5	4	3	5
148217000	H	LP	messing m.t.	60	15	12	1,5	4	3	20
148227000	V	LP	messing m.t.	60	15	12	1,5	4	3	20



## Skápalöm yfirfeld Galv.

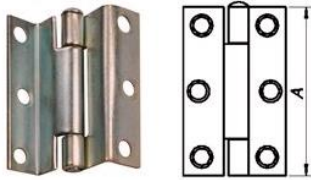

Art. nr.	Pakning	Overflade	A mm	B mm	C mm	Dim.	Tap	Skrue bolt	Stk. Pr. Enh.	Stk. pr. pk.
148503301	SB	elforzinket los s.t.	50	12	12	1	4	3,0	2	5
148603301	SB	elforzinket los s.t.	64	14	14	1,7	4	3,0	2	5

## Kantlamir kopar

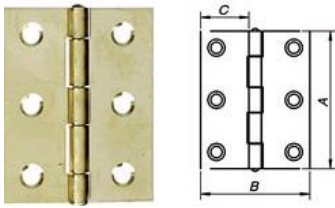

Art. nr.	Pakning	Overflade	A mm	B mm	C mm	Dim.	Tap	Skrue bolt	Stk. Pr. Enh.	Stk. pr. pk.
149107001	SB	messing	50	40	17	1,2	2	3	2	5
149207001	SB	messing	60	46	21	1,4	3	3	2	5
149307001	SB	messing	70	51	23	1,5	3	3,5	2	5

## Kantlamir þunnar

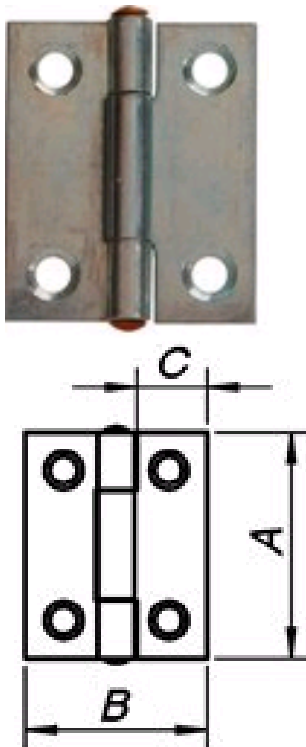

Art. nr.	Pakning	Overflade	A mm	B mm	C mm	Dim.	Skrue bolt	Stk. pr. pk.
149502300	LP	elforzinket m.t.	25	20	8	0,8	2,5	20
149502301	SB	elforzinket m.t.	25	20	8	0,8	2,5	10
149502307	KP	elforzinket m.t.	25	20	8	0,8	2,5	20
149507000	LP	messing	25	20	8	0,8	2,5	20
149507001	SB	messing	25	20	8	0,8	2,5	10
149507007	KP	messing	25	20	8	0,8	2,5	20
149602300	LP	elforzinket m.t.	30	22	9	0,9	2,5	20
149602301	SB	elforzinket m.t.	30	22	9	0,9	2,5	10
149602307	KP	elforzinket m.t.	30	22	9	0,9	2,5	20
149607000	LP	messing	30	22	9	0,9	2,5	20
149607001	SB	messing	30	22	9	0,9	2,5	10
149607007	KP	messing	30	22	9	0,9	2,5	20
149702300	LP	elforzinket m.t.	40	32	13,5	0,9	2,5	20
149702301	SB	elforzinket m.t.	40	32	13,5	0,9	2,5	10
149702307	KP	elforzinket m.t.	40	32	13,5	0,9	2,5	20
149707000	LP	messing	40	32	13,5	0,9	2,5	20
149707001	SB	messing	40	32	13,5	0,9	2,5	10
149707007	KP	messing	40	32	13,5	0,9	2,5	20

## Kantlamir bykkar

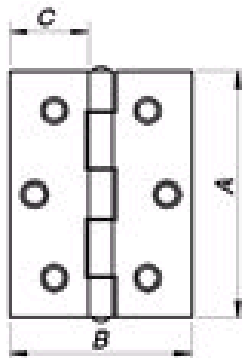
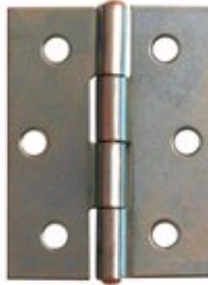

Art. nr.	Pakning	Overflade	A mm	B mm	C mm	Dim.	Tap	Skrue bolt	Stk. pr. pk.
150102300	LP	elforzinket. m.t.	50	37	16	1	3	2,6	20
150102301	SB	elforzinket m.t.	50	37	16	1	3	2,6	10
150102307	KP	elforzinket m.t.	50	37	16	1	3	2,6	20
150108907	KP	rustfrit stál	50	37	16	1	3	2,6	10
150202300	LP	elforzinket	63,5	44	18	1,5	3,5	3,5	20
150202301	SB	elforzinket m.t.	63,5	44	18	1,5	3,5	3,5	10
150202307	KP	elforzinket m.t.	63,5	44	18	1,5	3,5	3,5	20
150204300	LP	elforzinket løs m.t.	63,5	44	18	1,5	3,5	3,5	20
150208907	KP	rustfrit stál	63,5	44	18	1,5	3,5	3,5	10
150302300	LP	elforzinket m.t.	76,2	50	21	1,5	4	3,5	20
150302301	SB	elforzinket m.t.	76,2	50	21	1,5	4	3,5	10
150302303	LP	elforzinket m.t.	76,2	50	21	1,5	4	3,5	200
150302307	KP	elforzinket m.t.	76,2	50	21	1,5	4	3,5	20
150304300	LP	elforzinket løs m.t.	76,2	50	21	1,5	4	3,5	20
150308907	KP	rustfrit stál	76,2	50	21	1,5	4	3,5	10
150402300	LP	elforzinket m.t.	89	59	25	1,5	5	4,5	20
150402301	SB	elforzinket m.t.	89	59	25	1,5	5	4,5	5
150402307	KP	elforzinket	89	59	25	1,5	5	4,5	10
150408907	KP	rustfrit stál	89	59	25	1,5	5	4,5	10
150502300	LP	elforzinket m.t.	101	70	30	1,5	6,5	4,5	20
150502301	SB	elforzinket m.t.	101	70	30	1,5	6,5	4,5	5
150502307	KP	elforzinket m.t.	101	70	30	1,5	6,5	4,5	10

## Kantlöm samliða

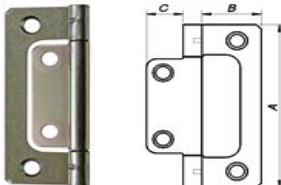

Art. nr.	Pakning	Overflade	A mm	B mm	C mm	Stk. pr. pk.
151002360	LP	elforzinket	76	23	14	20

## Kantlöm Rúnuð

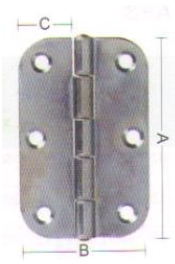

Art no.	Pakning	Overflade	A mm	B mm	C mm	Dim.	Tap	Skrue/bolt	Stk. pr. pk.
1603-0-23-00	LP	elforz. m.t.	76	50	21	1,5	4	3,5	20

## Stangarlöm



Art. nr.	Pakning	Overflade	A mm	B mm	Dim.	Skrue bolt	Stk. Pr. Enh.	Stk. pr. pk.
153001907	KP	stál formessinget	420	32	0,7	2,5	1	5
153101907	KP	stál formessinget	600	32	0,7	2,5	1	5
153107007	KP	messing	600	32	0,7	2,5	1	5
153201907	KP	stál formessinget	900	32	0,7	2,5	1	5
153207007	KP	messing	900	32	0,7	2,5	1	5
153301907	KP	stál formessinget	1200	32	0,7	2,5	1	5

## Blaölamir

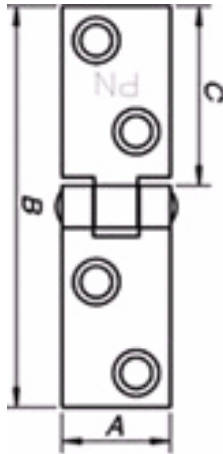

Art. nr.	Pakning	Overflade	A mm	B mm	C mm	Dim.	Tap	Skrue bolt	Stk. pr. pk.
170102300	LP	eiforzinket m.t.	19	70	32	1,5	4	3,5	20
170102301	SB	eiforzinket m.t.	19	70	32	1,5	4	3,5	10
170102307	LP	eiforzinket m.t.	19	70	32	1,5	4	3,5	20
170202300	LP	eiforzinket m.t.	26	70	32	1,5	4	3,5	20
170202301	SB	eiforzinket m.t.	26	70	32	1,5	4	3,5	10
170202307	KP	eiforzinket m.t.	26	70	32	1,5	4	3,5	20
170208907	LP	rustfrit stál	26	70	32	1,5	4	3,5	10
170302300	LP	eiforzinket m.t.	32	81	37	1,5	4	3,5	20
170302301	SB	eiforzinket m.t.	32	81	37	1,5	4	3,5	10
170302307	KP	eiforzinket m.t.	32	81	37	1,5	4	3,5	20
170402300	LP	eiforzinket m.t.	38	88	39	2	5	3,5	20
170402301	SB	eiforzinket m.t.	38	88	39	2	5	3,5	10
170402307	KP	eiforzinket m.t.	38	88	39	2	5	3,5	10
170408907	LP	rustfrit stál	38	88	39	2	5	3,5	10
170602300	LP	eiforzinket m.t.	50	114	52	2	6,5	4,5	20
170602301	SB	eiforzinket m.t.	50	114	52	2	6,5	4,5	10
170602307	KP	eiforzinket m.t.	50	114	52	2	6,5	4,5	10
170608907	LP	rustfrit stál	50	114	52	2	6,5	4,5	10
170802300	LP	eiforzinket m.t.	63	151	70	2,5	6,5	4,5	20
170802301	SB	eiforzinket m.t.	63	151	70	2,5	6,5	4,5	5
170802307	KP	eiforzinket m.t.	63	151	70	2,5	6,5	4,5	10
170902300	LP	eiforzinket m.t.	75	209	98	3	7	5	10
170902307	KP	eiforzinket m.t.	75	209	98	3	7	5	10

## Blaðlamir

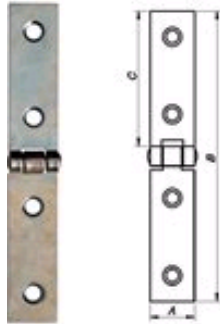

Art. nr.	Pakning	Overflade	A mm	B mm	C mm	Dim.	Tap	Skrue bolt	Stk. pr. pk.
172902300	LP	elforzinket m.t.	19	124	58	2	4	3,5	20
172902307	KP	elforzinket m.t.	19	124	58	2	4	3,5	20
173102300	LP	elforzinket m.t.	26	142	67	2	4	3,5	20
173102301	SB	elforzinket m.t.	26	142	67	2	4	3,5	10
173102307	KP	elforzinket m.t.	26	142	67	2	4	3,5	20
173108907	KP	rustfrit stál	26	142	67	2	4	3,5	10
173202300	LP	elforzinket m.t.	26	183	87	2	4	3,5	20
173202307	KP	elforzinket m.t.	26	183	87	2	4	3,5	20
173402300	LP	elforzinket m.t.	25	325	156	3	6	5	10
173402307	KP	elforzinket m.t.	25	325	156	3	6	5	10

## Vængjalamir

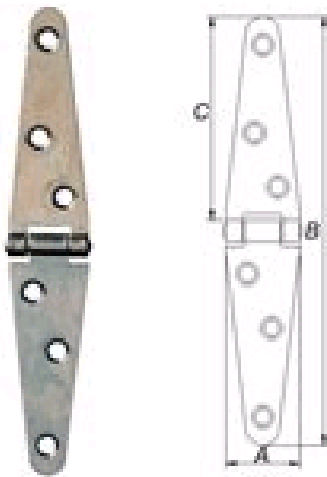

Art. nr.	Pakning	Overflade	A mm	B mm	C mm	Dim.	Tap	Skrue bolt	Stk. pr. pk.
173502300	LP	elforzinket m.t.	26	150	72	1,5	4	3,5	10
173502301	SB	elforzinket m.t.	26	150	72	1,5	4	3,5	5
173502307	KP	elforzinket m.t.	26	150	72	1,5	4	3,5	10
173602300	LP	elforzinket m.t.	30	200	97	1,5	4	3,5	10
173602301	SB	elforzinket m.t.	30	200	97	1,5	4	3,5	5
173602307	KP	elforzinket m.t.	30	200	97	1,5	4	3,5	10
173702300	LP	elforzinket m.t.	34	250	121	2	5	4	10
173702301	SB	elforzinket m.t.	34	250	121	2	5	4	5
173702307	KP	elforzinket m.t.	34	250	121	2	5	4	10
173802300	LP	elforzinket m.t.	38	300	145	2	5	4	10
173802301	SB	elforzinket m.t.	38	300	145	2	5	4	5
173802307	KP	elforzinket m.t.	38	300	145	2	5	4	10

## Blaðlöm Heitgalv.

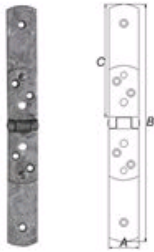

Art. nr.	Pakning	Overflade	A mm	B mm	C mm	Dim.	Tap	Skrue bolt	Stk. pr. pk.
175102107	KP	varmforzinket m.t	38	302	145	2,5	8	5	1
175302107	KP	varmforzinket m.t.	50	465	225	3	9,5	5	1

## “T” lamir

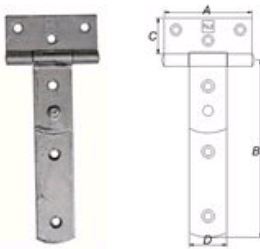

Art. nr.	Pakning	Overflade	A mm	B mm	C mm	D mm	Dim.	Tap	Skrue bolt
176102107	KP	varmforzinket m.t.	75	152	31	32	2	6,5	4,5
176202107	KP	varmforzinket m.t.	100	227	31	32	2,5	8	5
176208907	KP	rustfrit stál	100	227	31	32	2,5	8	5
176302107	KP	varmforzinket m.t.	100	310	31	32	2,5	8	5
176308907	KP	rustfrit stál	100	310	31	32	2,5	8	5
176502107	KP	varmforzinket m.t	100	390	31	32	2,5	8	5
176602107	KP	varmforzinket m.t	100	470	31	32	2,5	8	5

## Tröppulöm m/krók

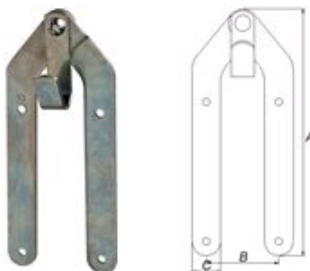

Art. nr.	Pakning	Overflade	A mm	B mm	C mm	Dim.	Skrue bolt	Stk. pr. pk.
180200300		elforzinket	213	63	25	4	6,5	1

### Hurðalamir m/Hring



Hægri 125x51: **118612100** Vinstri 125x51: **118622100**

### Blaðlöm RYDF Planar

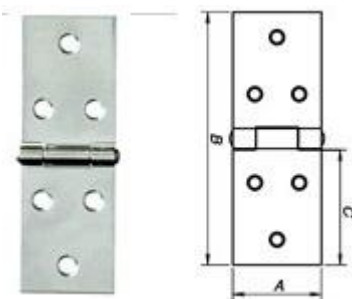

28x80mm: **172308900**

32x100mm: **172408900**

33x120mm: **172608900**